

Customer:		Ref.:	
Item	Quantity	Required flow	n.d.
Type	CENTRIFUGAL PUMP WITH HORIZONTAL SHAFT	Model	NCH50-315

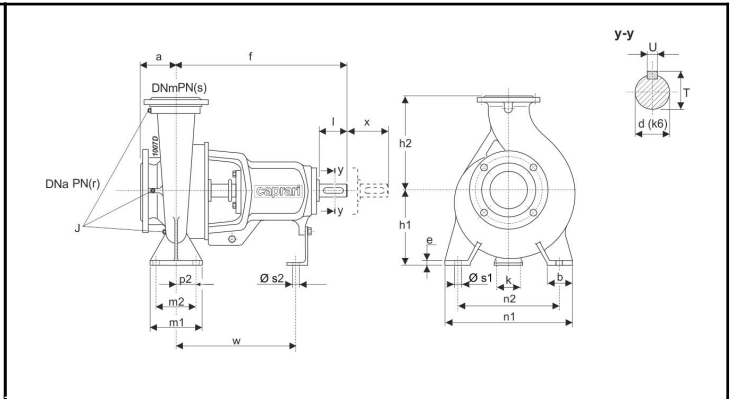
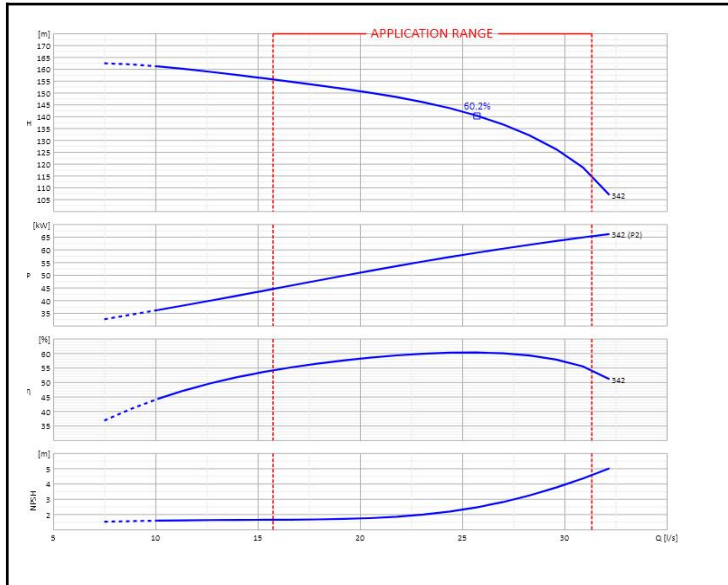

DNm	50	f	500	n2	280
DNa	80	k	110	p2	n.d.
J	G1/4x3	l	80	s2	14
T	35	r	16	h1	225
U	10	s	25	m1	125
a	125	w	370	n1	345
b	65	x	100	s1	14
d	32	h2	280		
e	18	m2	95		

OPERATING DATA - ISO 9906:2012 3B - M.E.I. ≥ 0.40					CONSTRUCTION CHARACTERISTICS			
Q [l/s]	H [m]	P [kW]	η [%]	NPSH [m]	UNI delivery flange DN	50	PN	25
					UNI suction flange DN	80	PN	16
					Total weight	87		Kg
					No. Stages	1		
					Pump seal	Mechanical		
					Type of installation	Horizontal		

OPERATING LIMITS			OPERATING CHARACTERISTICS			
Pumped liquid	Water		Service flow rate		n.d.	n.d.
Max. temperature of pumped liquid	n.d.		Service head		n.d.	n.d.
Maximum density	1	kg/dm³	Qmin	Qmax	15.73	31.32
Maximum viscosity	1	mm²/s	H (Q=0) Hmax (Qmin)		163.4	155.58
Max. solid content	50	g/m³	P2 Duty Point	P2max	n.d.	65.19
Max. no. starts/hr	n.d.		Pump hydraulic efficiency		n.d.	n.d.
Maximum operating time with closed port	2min (3500 rpm) 6min (1450 rpm) [40 °C]		Rotation speed		2900	1/min
			Sense of rotation (*)		Clockwise	
			Number of pumps installed		Operating	Stand-by
					1	0

PUMP MATERIALS	
Pump casing	Cast iron
Impeller	Cast iron
Lantern bracket	Cast iron
Shaft	Stainless steel
Wear ring	Cast iron
Support	Cast iron
Bearing	n.d.
Water retainer ring	Nitrile rubber
Feather key	Stainless steel
Feather key 2	Steel
Seal ring	Nitrile rubber
Mechanical seal	Silicon carbide/silicon carbide
Spacer sleeve	Stainless steel
Seal ring	Nitrile rubber
Cover mechanical seal	Cast iron
Duck foot pedestal	Steel
Cover bearing	Cast iron

Notes:	(*) View from motor coupling side	
OFFER No.	Pos.	Date 16/01/2020