

Customer:		Ref.:	
Item	Quantity	Required flow	n.d.
Type	CENTRIFUGAL PUMP WITH HORIZONTAL SHAFT	Model	NC100-400

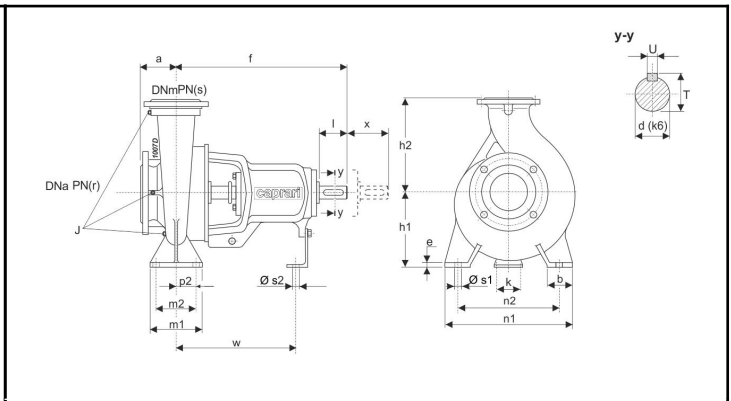
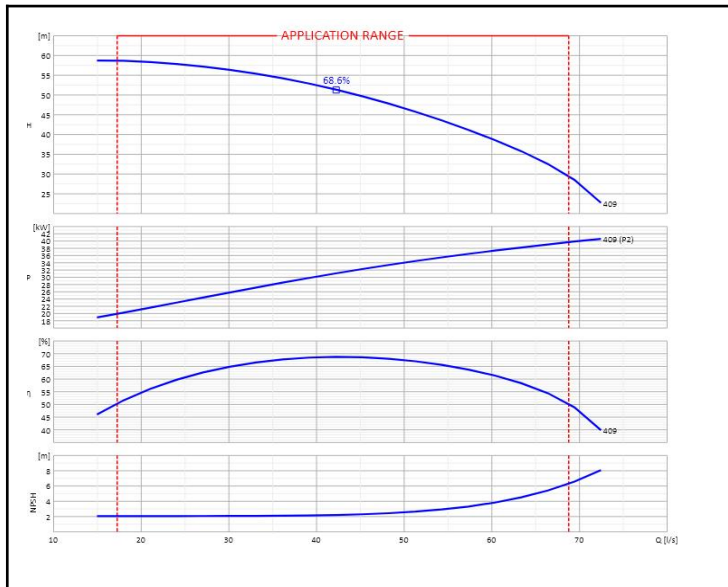

DNm	100	f	530	n2	400
DNa	125	k	110	p2	n.d.
J	G3/8x2	l	110	s2	14
T	45	r	16	h1	280
U	12	s	16	m1	200
a	140	w	370	n1	500
b	100	x	140	s1	23
d	42	h2	355		
e	18	m2	150		

OPERATING DATA - UNI/ISO 9906:2012 grade 3B - M.E.I.≥0.40					CONSTRUCTION CHARACTERISTICS				
Q [l/s]	H [m]	P [kW]	η [%]	NPSH [m]	UNI delivery flange DN		100	PN	16
					UNI suction flange DN		125	PN	16
					Total weight		174		Kg
					No. Stages		1		
					Pump seal		Mechanical		
					Type of installation		Horizontal		

OPERATING LIMITS			OPERATING CHARACTERISTICS			
Pumped liquid	Water		Service flow rate		n.d.	n.d.
Max. temperature of pumped liquid	n.d.		Service head		n.d.	n.d.
Maximum density	1	kg/dm³	Qmin	Qmax	17.24	68.76
Maximum viscosity	1	mm²/s	H (Q=0) Hmax (Qmin)		58.61	58.59
Max. solid content	50	g/m³	P2 Duty Point	P2max	n.d.	39.56
Max. no. starts/hr	n.d.		Pump hydraulic efficiency		n.d.	n.d.
Maximum operating time with closed port	2min (3500 rpm) 6min (1450 rpm) [40 °C]		Rotation speed		1450	1/min
			Sense of rotation (*)		Clockwise	
			Number of pumps installed		Operating	Stand-by
					1	0

PUMP MATERIALS			
Pump casing	Cast iron	Stuffing box	n.d.
Impeller	Cast iron	Duck foot pedestal	Steel
Lantern bracket	Cast iron	Cover bearing	Cast iron
Shaft	Stainless steel		
Wear ring	Cast iron		
Support	Cast iron		
Bearing	n.d.		
Water retainer ring	Nitrile rubber		
Feather key	Stainless steel		
Feather key 2	Steel		
Seal ring	Nitrile rubber		
Mechanical seal	Silicon carbide/silicon carbide		
Packing	n.d.		
Spacer sleeve	Stainless steel		
Shaft sleeve	n.d.		
Seal ring	Nitrile rubber		
Cover mechanical seal	Cast iron		

Notes:	(*) View from motor coupling side		
OFFER No.	Pos.	Date 16/01/2020	