

Customer:		Ref.:	
Item	Quantity	Required flow	n.d.
Type	CENTRIFUGAL PUMP WITH HORIZONTAL SHAFT	Model	NC40-250

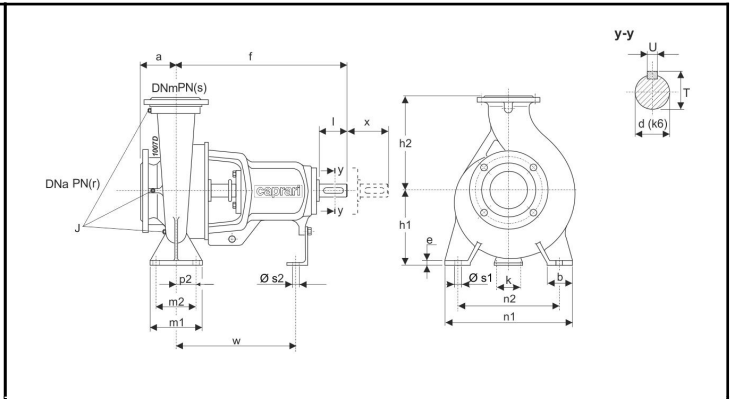
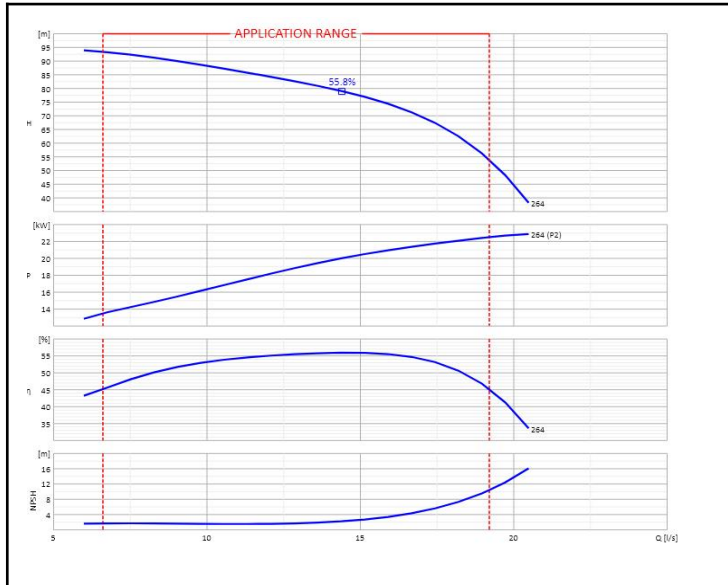

DNm	40	f	360	n2	250
DNa	65	k	110	p2	n.d.
J	G1/4, G3	l	50	s2	14
T	27	r	16	h1	180
U	8	s	16	m1	125
a	100	w	260	n1	320
b	65	x	100	s1	14
d	24	h2	225		
e	14	m2	95		

OPERATING DATA - UNI/ISO 9906:2012 grade 3B - M.E.I. ≥ 0.40					CONSTRUCTION CHARACTERISTICS			
Q [l/s]	H [m]	P [kW]	η [%]	NPSH [m]	UNI delivery flange DN	40	PN	16
					UNI suction flange DN	65	PN	16
					Total weight	61		Kg
					No. Stages	1		
					Pump seal	Mechanical		
					Type of installation	Horizontal		

OPERATING LIMITS			OPERATING CHARACTERISTICS			
Pumped liquid	Water		Service flow rate		n.d.	n.d.
Max. temperature of pumped liquid	n.d.		Service head		n.d.	n.d.
Maximum density	1	kg/dm³	Qmin	Qmax	6.61	19.21
Maximum viscosity	1	mm²/s	H (Q=0) Hmax (Qmin)		94.3	93.24
Max. solid content	50	g/m³	P2 Duty Point	P2max	n.d.	22.44
Max. no. starts/hr	n.d.		Pump hydraulic efficiency		n.d.	n.d.
Maximum operating time with closed port	2min (3500 rpm) 6min (1450 rpm) [40 °C]		Rotation speed		2900	1/min
			Sense of rotation (*)		Clockwise	
			Number of pumps installed		Operating	Stand-by
					1	0

PUMP MATERIALS			
Pump casing	Cast iron	Stuffing box	n.d.
Impeller	Cast iron	Duck foot pedestal	Steel
Lantern bracket	Cast iron	Cover bearing	Cast iron
Shaft	Stainless steel		
Wear ring	Cast iron		
Support	Cast iron		
Bearing	n.d.		
Water retainer ring	Nitrile rubber		
Feather key	Stainless steel		
Feather key 2	Steel		
Seal ring	Nitrile rubber		
Mechanical seal	Silicon carbide/silicon carbide		
Packing	n.d.		
Spacer sleeve	Stainless steel		
Shaft sleeve	n.d.		
Seal ring	Nitrile rubber		
Cover mechanical seal	Cast iron		

Notes:	(*) View from motor coupling side		
OFFER No.	Pos.	Date	
		16/01/2020	